



# MMBT1616/A

## NPN EPITAXIAL SILICON TRANSISTOR

### NPN EPITAXIAL SILICON TRANSISTOR

#### DESCRIPTION

- \* Audio frequency power amplifier
- \* Medium speed switching

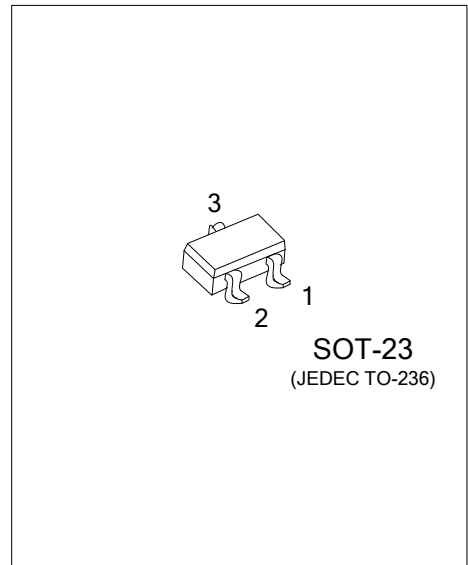

#### ORDERING INFORMATION

Order Number	Package	Pin Assignment			Packing
		1	2	3	
MMBT1616G-x-AE3-R	SOT-23	E	B	C	Tape Reel
MMBT1616AG-x-AE3-R	SOT-23	E	B	C	Tape Reel

Note: Pin Assignment: E: Emitter    B: Base    C: Collector

<p>MMBT1616G-x-AE3-R</p> <p>(1) Packing Type (2) Package Type (3) Rank (4) Green Package</p>	<p>(1) R: Tape Reel (2) AE3: SOT-23 (3) x: refer to Classification of <math>h_{FE1}</math> (4) L: Lead Free, G: Halogen Free and Lead Free</p>
--	--

#### MARKING

UTC MMBT1616	UTC MMBT1616A

# MMBT1616/A

## NPN EPITAXIAL SILICON TRANSISTOR

### ■ ABSOLUTE MAXIMUM RATING (T<sub>A</sub>=25°C, unless otherwise specified)

PARAMETER	SYMBOL	RATINGS	UNIT	
Collector to Base Voltage	MMBT1616	60	V	
	MMBT1616A	120		
Collector to Emitter Voltage	MMBT1616	50	V	
	MMBT1616A	60		
Emitter to Base Voltage	V <sub>EBO</sub>	6	V	
Collector Current	DC	I <sub>C</sub>	1	A
Collector Current	Pulse	I <sub>C</sub>	2	A
Total Power Dissipation (T <sub>A</sub> =25°C)	P <sub>D</sub>	350	mW	
Junction Temperature	T <sub>J</sub>	+150	°C	
Storage Temperature	T <sub>STG</sub>	-55 ~ +150	°C	

Note (\*) Pulse width ≤ 10ms, Duty cycle < 50%

1. Absolute maximum ratings are those values beyond which the device could be permanently damaged. Absolute maximum ratings are stress ratings only and functional device operation is not implied.

### ■ ELECTRICAL CHARACTERISTICS (T<sub>A</sub>=25°C, unless otherwise specified)

PARAMETER	SYMBOL	TEST CONDITIONS	MIN	TYP	MAX	UNIT
Collector Cut-Off Current	I <sub>CBO</sub>	V <sub>CB</sub> =60V			100	nA
Emitter Cut-Off Current	I <sub>EBO</sub>	V <sub>EB</sub> =6V			100	nA
Collector-Emitter Saturation Voltage	V <sub>CE(SAT)</sub>	I <sub>C</sub> =1A, I <sub>B</sub> =50mA		0.15	0.3	V
Base-Emitter Saturation Voltage	V <sub>BE(SAT)</sub>	I <sub>C</sub> =1A, I <sub>B</sub> =50mA		0.9	1.2	V
Base Emitter On Voltage	V <sub>BE(ON)</sub>	V <sub>CE</sub> =2V, I <sub>C</sub> =50mA	600	640	700	mV
DC Current Gain	h <sub>FE1</sub>	V <sub>CE</sub> =2V, I <sub>C</sub> =100mA	135		600	
	h <sub>FE2</sub>	V <sub>CE</sub> =2V, I <sub>C</sub> =1A	81			
Current Gain Bandwidth Product	f <sub>T</sub>	V <sub>CE</sub> =2V, I <sub>C</sub> =100mA	100	160		MHz
Output Capacitance	C <sub>ob</sub>	V <sub>CB</sub> =10V, f=1MHz			19	pF
Turn On Time	t <sub>on</sub>	V <sub>CE</sub> =10V, I <sub>C</sub> =100mA		0.07		us
Storage Time	t <sub>s</sub>	I <sub>B1</sub> =-I <sub>B2</sub> =10mA		0.95		us
Fall Time	t <sub>f</sub>	V <sub>BE(off)</sub> =-2~-3V		0.07		us

### ■ CLASSIFICATION OF h<sub>FE1</sub>

RANK	Y	G	L
h <sub>FE1</sub>	135-270	200-400	300-600

## TYPICAL CHARACTERISTICS

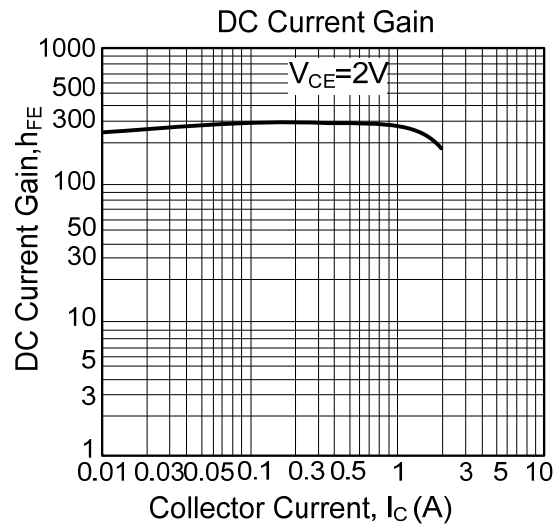
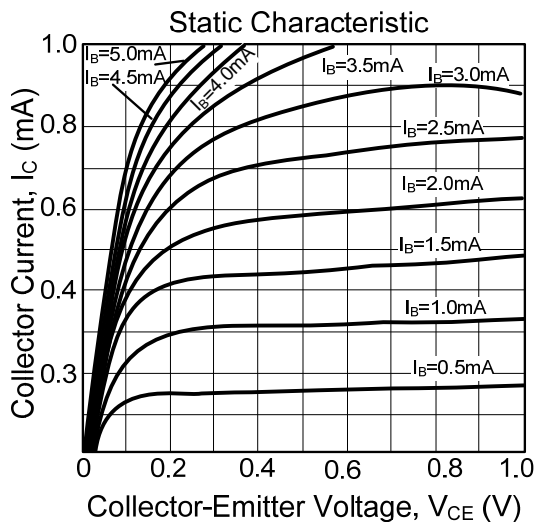
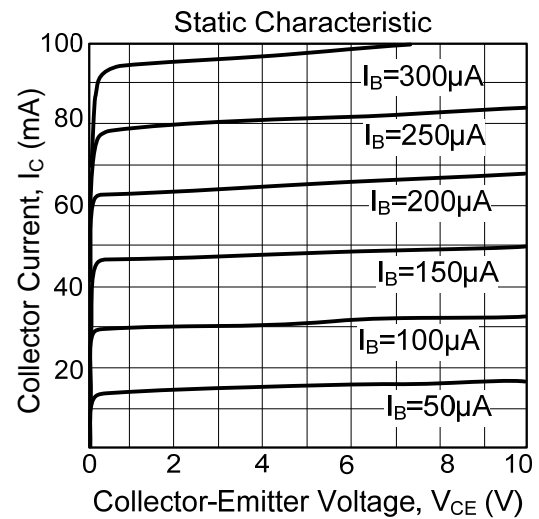
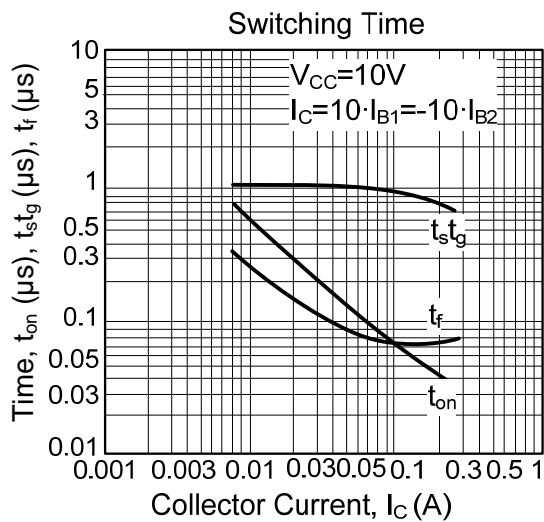
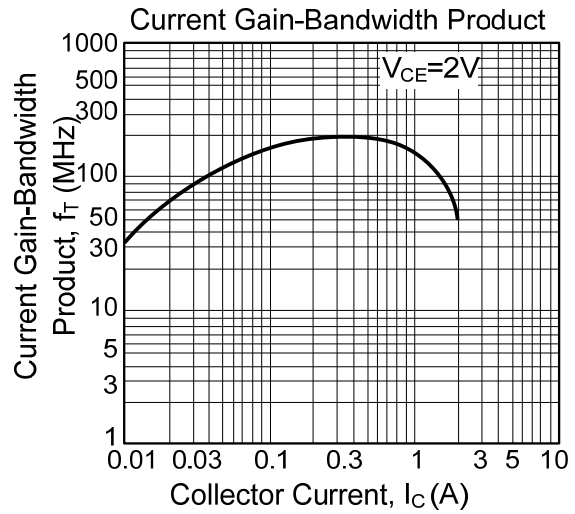
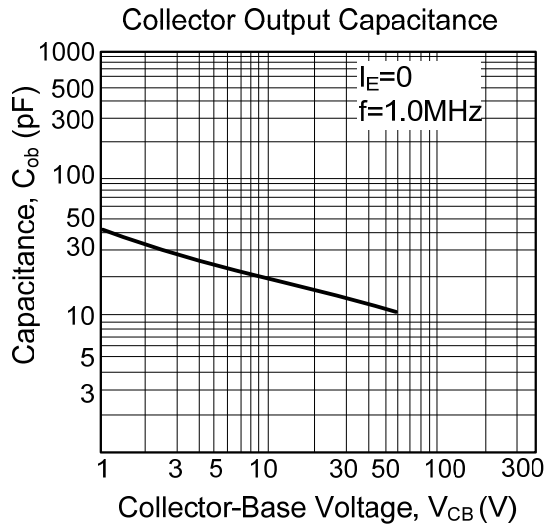

■ TYPICAL CHARACTERISTICS(Cont.)

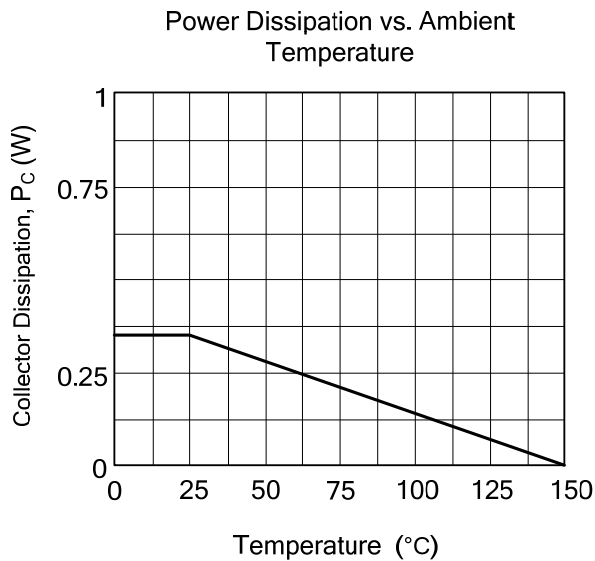
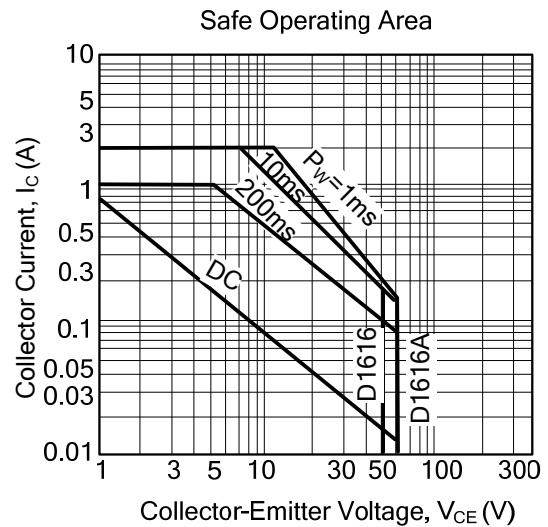
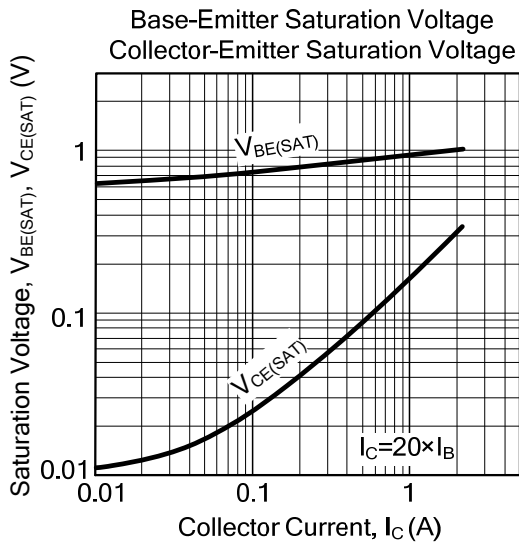

UTC assumes no responsibility for equipment failures that result from using products at values that exceed, even momentarily, rated values (such as maximum ratings, operating condition ranges, or other parameters) listed in products specifications of any and all UTC products described or contained herein. UTC products are not designed for use in life support appliances, devices or systems where malfunction of these products can be reasonably expected to result in personal injury. Reproduction in whole or in part is prohibited without the prior written consent of the copyright owner. The information presented in this document does not form part of any quotation or contract, is believed to be accurate and reliable and may be changed without notice.