



UT3458

Power MOSFET

4.1A, 60V N-CHANNEL POWER MOSFET

DESCRIPTION

The UTC **UT3458** is N-channel enhancement mode power MOSFET using UTC's advanced technology to provide the customers with perfect $R_{DS(ON)}$ and low gate charge. This device can be operated with 4.5V low gate voltage.

FEATURES

- * $V_{DS}=60V$
- * $I_D=4.1A$
- * $R_{DS(ON)}<0.1\Omega @ V_{GS}=10V, I_D=3.2A$
- * $R_{DS(ON)}<0.128\Omega @ V_{GS}=4.5V, I_D=2.8A$

SYMBOL

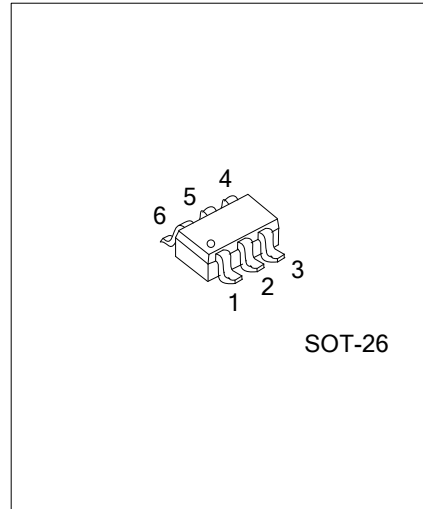
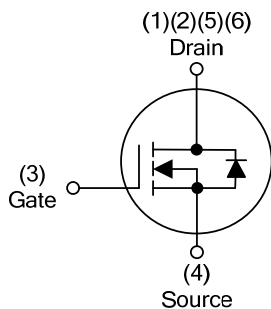

ORDERING INFORMATION

Ordering Number	Package	Pin Assignment						Packing
		1	2	3	4	5	6	
UT3458G-AG6-R	SOT-26	D	D	G	S	D	D	Tape Reel

Note: Pin Assignment: G: Gate D: Drain S: Source

<p>UT3458G-AG6-R</p> <ul style="list-style-type: none"> (1) Packing Type (2) Package Type (3) Green Package 	<ul style="list-style-type: none"> (1) R: Tape Reel (2) AG6: SOT-26 (3) G: Halogen Free and Lead Free
--	--

MARKING

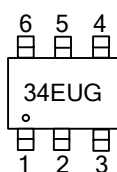

■ ABSOLUTE MAXIMUM RATINGS ($T_c=25^\circ\text{C}$, unless otherwise specified)

PARAMETER			SYMBOL	RATINGS	UNIT
Drain-Source Voltage			V_{DSS}	60	V
Gate-Source Voltage			V_{GSS}	± 20	V
Drain Current	Continuous (Note 2, 3)	$T_A=25^\circ\text{C}$	I_D	4.1	A
		$T_A=70^\circ\text{C}$		3.2	A
	Pulsed		I_{DM}	15	A
Power Dissipation (Note 2, 3)			P_D	2	W
Junction Temperature			T_J	+150	$^\circ\text{C}$
Storage Temperature			T_{STG}	-55~+150	$^\circ\text{C}$

Notes: 1. Absolute maximum ratings are those values beyond which the device could be permanently damaged.

Absolute maximum ratings are stress ratings only and functional device operation is not implied..

2. Surface Mounted on FR4 Board.

3. $t \leq 5$ sec

■ THERMAL CHARACTERISTICS

PARAMETER	SYMBOL	RATINGS	UNIT
Junction to Ambient (Note 2)	θ_{JA}	62.5	$^\circ\text{C}/\text{W}$

■ ELECTRICAL CHARACTERISTICS (T_J=25°C, unless otherwise noted)

PARAMETER	SYMBOL	TEST CONDITIONS	MIN	TYP	MAX	UNIT	
OFF CHARACTERISTICS							
Drain-Source Breakdown Voltage	BV _{DSS}	I _D =250μA, V _{GS} =0V	60			V	
Drain-Source Leakage Current	I _{DSS}	V _{DS} =60V, V _{GS} =0V			1	μA	
		V _{DS} =60V, V _{GS} =0V, T _J =70°C			10	μA	
Gate- Source Leakage Current	Forward	I _{GSS}					
	Reverse						V _{GS} =+20V, V _{DS} =0V
		V _{GS} =-20V, V _{DS} =0V			-100	nA	
ON CHARACTERISTICS							
Gate Threshold Voltage	V _{GS(TH)}	V _{DS} =V _{GS} , I _D =250μA	1.5		3	V	
Static Drain-Source On-State Resistance	R _{DS(ON)}	V _{GS} =10V, I _D =3.2A		0.082	0.1	Ω	
		V _{GS} =4.5V, I _D =2.8A		0.105	0.128	Ω	
On State Drain Current	I _{D(ON)}	V _{GS} =10V, V _{DS} =5V	10			A	
SWITCHING PARAMETERS							
Input Capacitance	C _{ISS}	V _{DS} =30 V, V _{GS} = 0V, f = 1MHz		350		pF	
Output Capacitance	C _{OSS}			40			
Reverse Transfer Capacitance	C _{RSS}			20			
Total Gate Charge	Q _G	V _{DS} =10V, V _{DS} =48V, I _D =3.2A		7.1	11	nC	
		V _{DS} =4.5V, V _{DS} =48V, I _D =3.2A		3.5	5.5		
Gate to Source Charge	Q _{GS}	V _{DS} =4.5V, V _{DS} =48V, I _D =3.2A		1.1		nC	
Gate to Drain Charge	Q _{GD}			0.95			
Turn-ON Delay Time	t _{D(ON)}	V _{DD} =30V, I _D ≈2.5A, R _L =12Ω, V _{GEN} =4.5V, R _G =1Ω(Note 1, 2)		16	25	ns	
Rise Time	t _R			17	30		
Turn-OFF Delay Time	t _{D(OFF)}			12	20		
Fall Time	t _F			10	15		
Turn-ON Delay Time	t _{D(ON)}		V _{DD} =30V, I _D ≈2.5A, R _L =12Ω, V _{GEN} =10V, R _G =2.5Ω(Note 1, 2)		5		10
Rise Time	t _R				12		20
Turn-OFF Delay Time	t _{D(OFF)}			18	30		
Fall Time	t _F			10	15		
SOURCE- DRAIN DIODE RATINGS AND CHARACTERISTICS							
Maximum Body-Diode Continuous Current	I _S				2.9	A	
Maximum Body-Diode Pulsed Current	I _{SM}				10	A	
Drain-Source Diode Forward Voltage	V _{SD}	I _S =2.5A, V _{GS} =0V		0.8	1.2	V	
Body Diode Reverse Recovery Time	t _{RR}	I _F =2.5A, di/dt=100A/μs (Note 1)		25	50	ns	

Notes: 1. Pulse Test: Pulse width ≤ 300μs, Duty cycle ≤ 2%

2. Guaranteed by design, not subject to production testing

■ TYPICAL CHARACTERISTICS

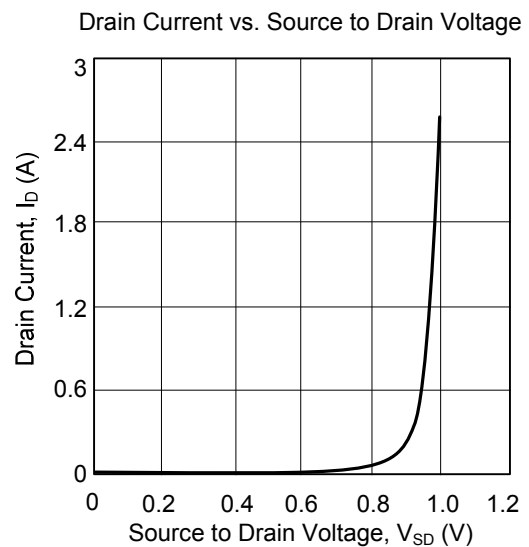
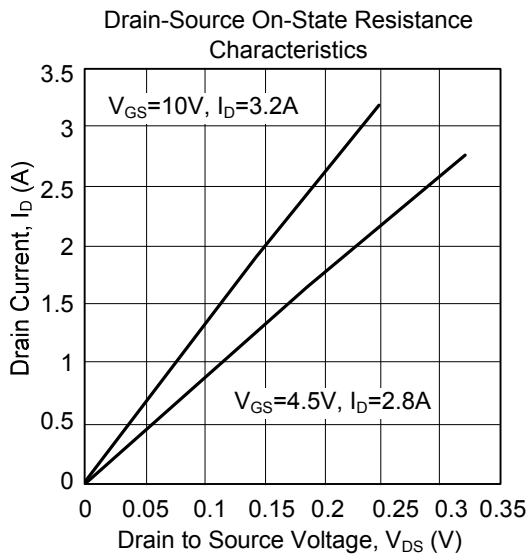
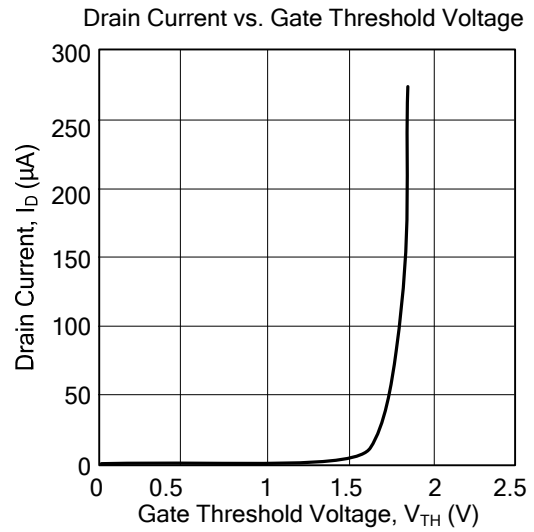
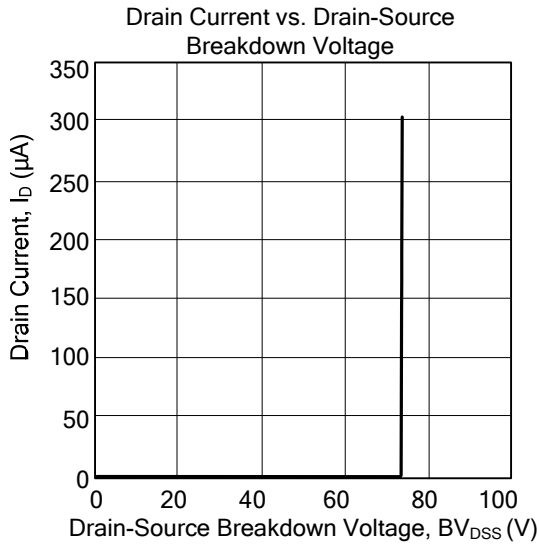

UTC assumes no responsibility for equipment failures that result from using products at values that exceed, even momentarily, rated values (such as maximum ratings, operating condition ranges, or other parameters) listed in products specifications of any and all UTC products described or contained herein. UTC products are not designed for use in life support appliances, devices or systems where malfunction of these products can be reasonably expected to result in personal injury. Reproduction in whole or in part is prohibited without the prior written consent of the copyright owner. The information presented in this document does not form part of any quotation or contract, is believed to be accurate and reliable and may be changed without notice.